

Article number: 201226045

Description: E+G Magnets with bore GN 50.4-HF-63-14-6,5
Hard ferrite - 200° C, 290N

Measures

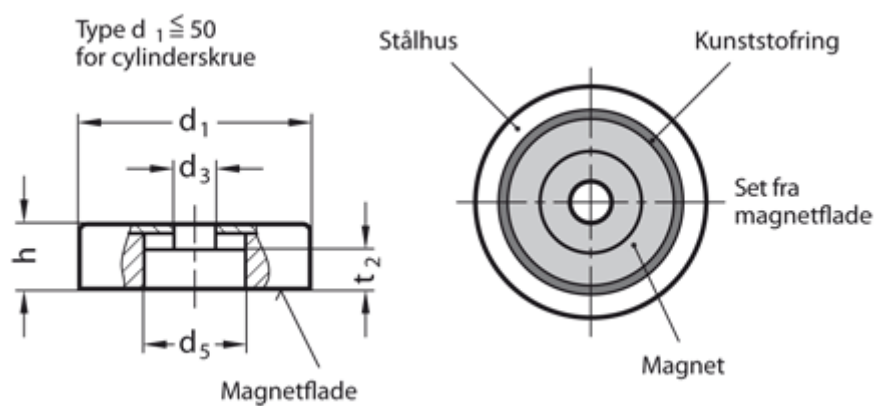

d1 = 63 +0,3/-0,1

d3 = 6.5

d5 = 24.0

h = 14 +0,5/-0,1

Holding force N = 290

Material = HF hard ferrite - 200°.C

t2 = 12.0